

SKM 100GB125DN

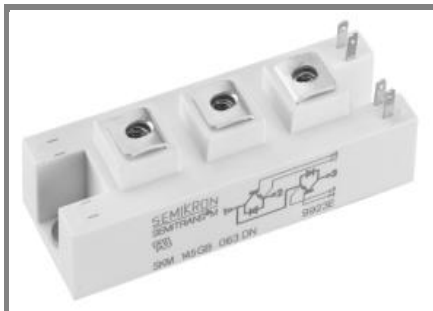

SEMITRANS™ 2N

Ultra Fast IGBT Module

SKM 100GB125DN

Features

- N channel, homogeneous Si
- Low inductance case
- Short tail current with low temperature dependence
- High short circuit capability, self limiting to $6 \times I_{Cnom}$
- Fast & soft inverse CAL diodes
- Isolated copper baseplate using DCB Direct Copper Bonding Technology
- Large clearance (10 mm) and creepage distances (20 mm)

Typical Applications

- Switched mode power supplies at $f_{sw} > 20$ kHz
- Resonant inverters up to 100 kHz
- Inductive heating
- Electronic welders at $f_{sw} > 20$ kHz

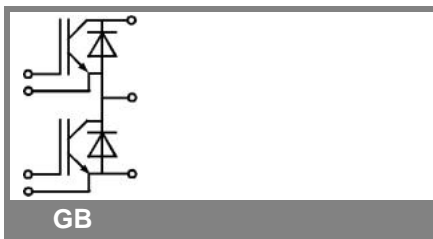

Absolute Maximum Ratings		$T_c = 25^\circ\text{C}$, unless otherwise specified	
Symbol	Conditions	Values	Units
IGBT			
V_{CES}		1200	V
I_C	$T_c = 25$ (85) $^\circ\text{C}$	100 (80)	A
I_{CRM}	$t_p = 1$ ms	150	A
V_{GES}		± 20	V
T_{vj} (T_{stg})	$T_{OPERATION} \leq T_{stg}$	- 40 ... + 150 (125)	$^\circ\text{C}$
V_{isol}	AC, 1 min.	4000	V
Inverse diode			
I_F	$T_c = 25$ (80) $^\circ\text{C}$	95 (65)	A
I_{FRM}	$t_p = 1$ ms	150	A
I_{FSM}	$t_p = 10$ ms; sin.; $T_j = 150^\circ\text{C}$	720	A

Characteristics		$T_c = 25^\circ\text{C}$, unless otherwise specified			
Symbol	Conditions	min.	typ.	max.	Units
IGBT					
$V_{GE(th)}$	$V_{GE} = V_{CE}$, $I_C = 2$ mA	4,5	5,5	6,5	V
I_{CES}	$V_{GE} = 0$, $V_{CE} = V_{CES}$, $T_j = 25$ (125) $^\circ\text{C}$		0,15	0,45	mA
$V_{CE(TO)}$	$T_j = 25$ (125) $^\circ\text{C}$				V
r_{CE}	$V_{GE} = 15$ V, $T_j = 25$ (125) $^\circ\text{C}$				m Ω
$V_{CE(sat)}$	$I_{Cnom} = 75$ A, $V_{GE} = 15$ V, chip level		3,3	3,85	V
C_{ies}	under following conditions		5	6,6	nF
C_{oes}	$V_{GE} = 0$, $V_{CE} = 25$ V, $f = 1$ MHz		0,72	0,9	nF
C_{res}			0,38	0,5	nF
L_{CE}				25	nH
$R_{CC'+EE'}$	res., terminal-chip $T_c = ^\circ\text{C}$				m Ω
$t_{d(on)}$	$V_{CC} = 600$ V, $I_{Cnom} = 75$ A		80		ns
t_r	$R_{Gon} = R_{Goff} = 8 \Omega$, $T_j = 125^\circ\text{C}$		40		ns
$t_{d(off)}$	$V_{GE} = \pm 15$ V		360		ns
t_f			20		ns
$E_{on} (E_{off})$			9 (3,5)		mJ
Inverse diode					
$V_F = V_{EC}$	$I_{Fnom} = 75$ A; $V_{GE} = 0$ V; $T_j = 25$ (125) $^\circ\text{C}$		2 (1,8)	2,5	V
$V_{(TO)}$	$T_j = 25$ (125) $^\circ\text{C}$		1,1	1,2	V
r_T	$T_j = 25$ (125) $^\circ\text{C}$		12	17,3	m Ω
I_{RRM}	$I_{Fnom} = 75$ A; $T_j = 125$ () $^\circ\text{C}$		50		A
Q_{rr}	$di/dt = 800$ A/ μs		11,5		μC
E_{rr}	$V_{GE} = 0$ V		4		mJ
Thermal characteristics					
$R_{th(j-c)}$	per IGBT			0,18	K/W
$R_{th(j-c)D}$	per Inverse Diode			0,5	K/W
$R_{th(c-s)}$	per module			0,05	K/W
Mechanical data					
M_s	to heatsink M6	3		5	Nm
M_t	to terminals M5	2,5		5	Nm
w				160	g

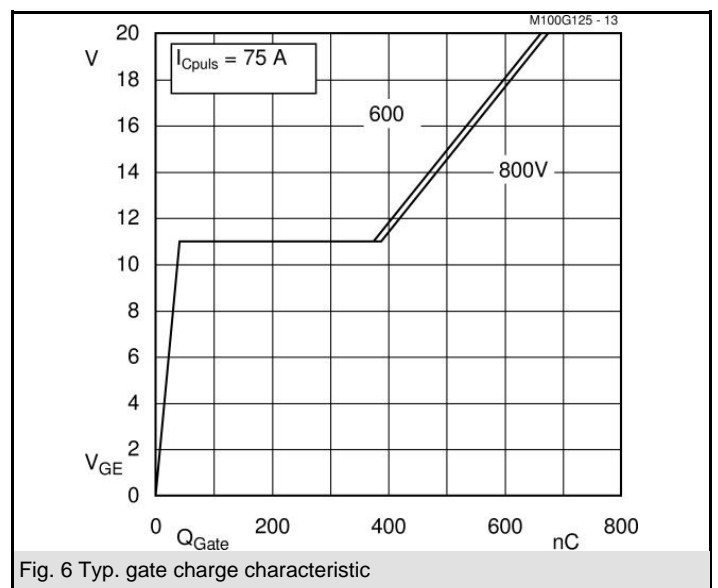
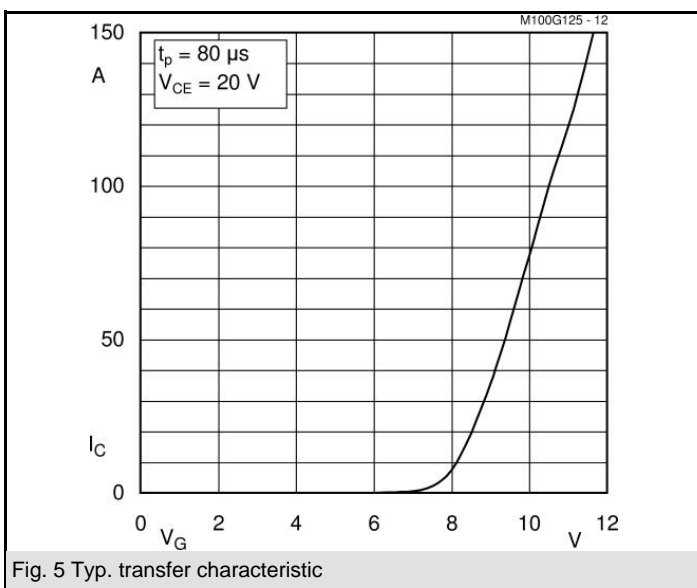
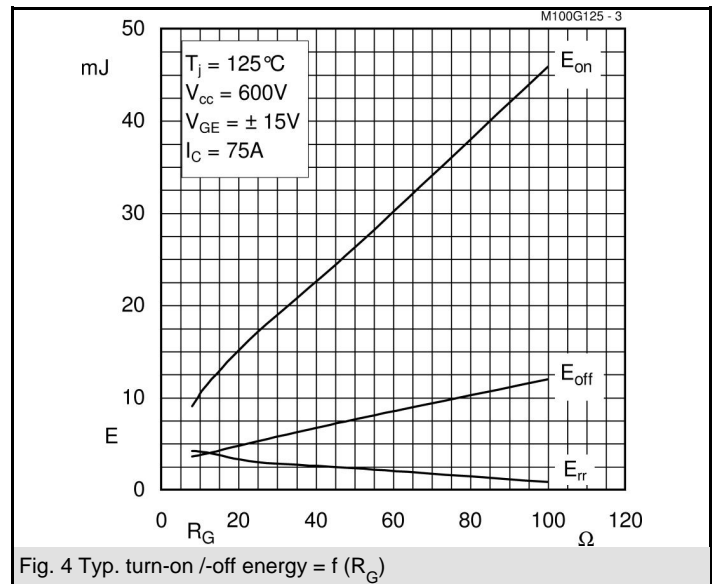
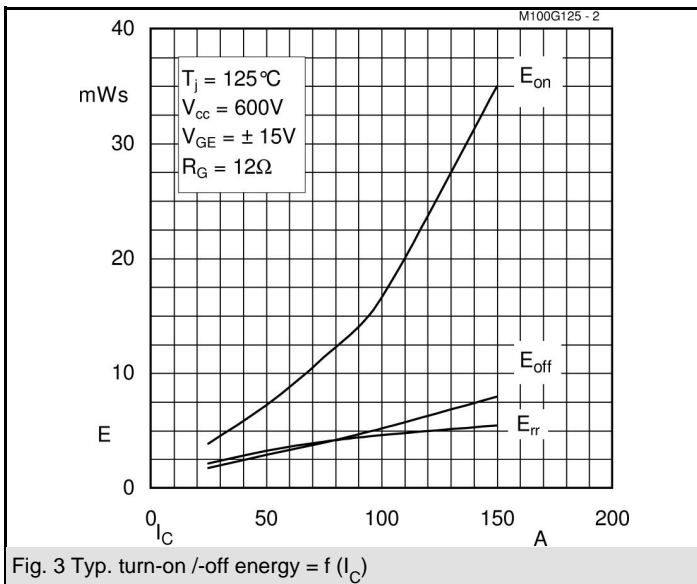
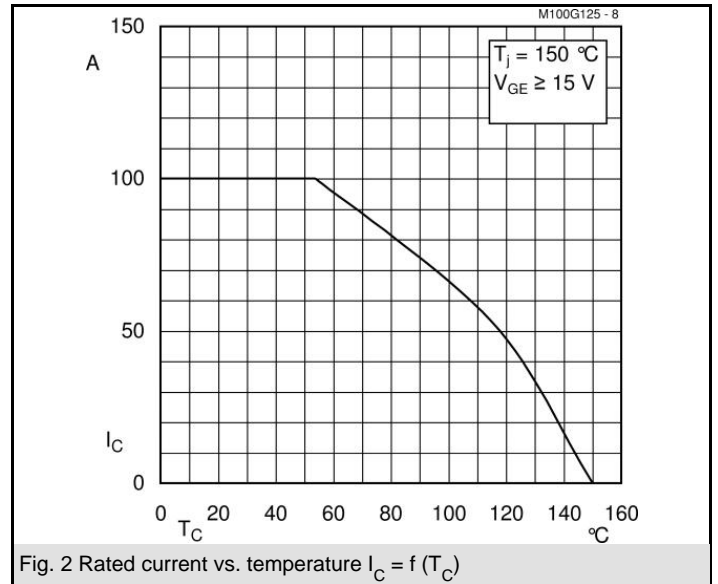
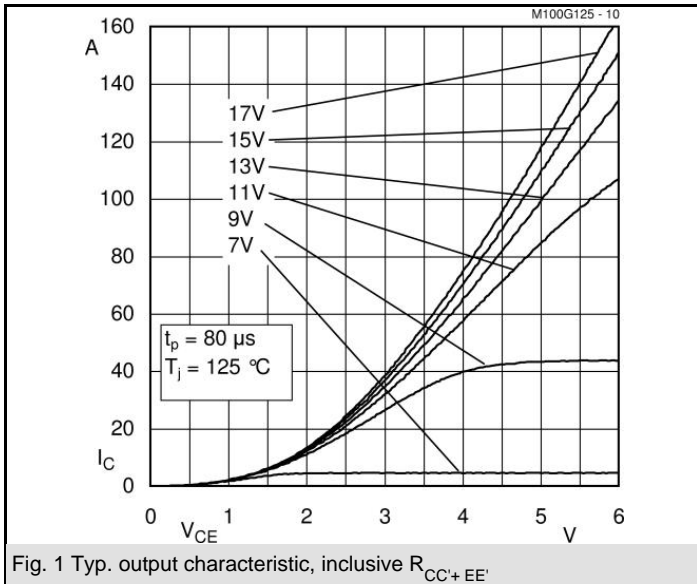

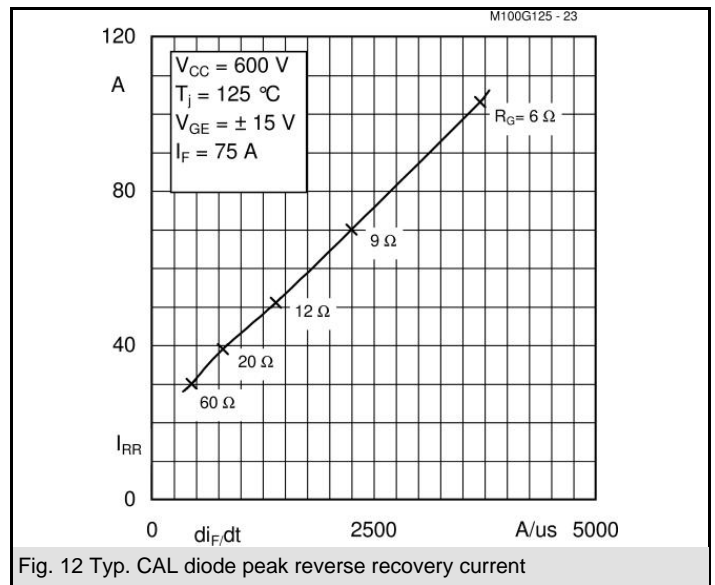
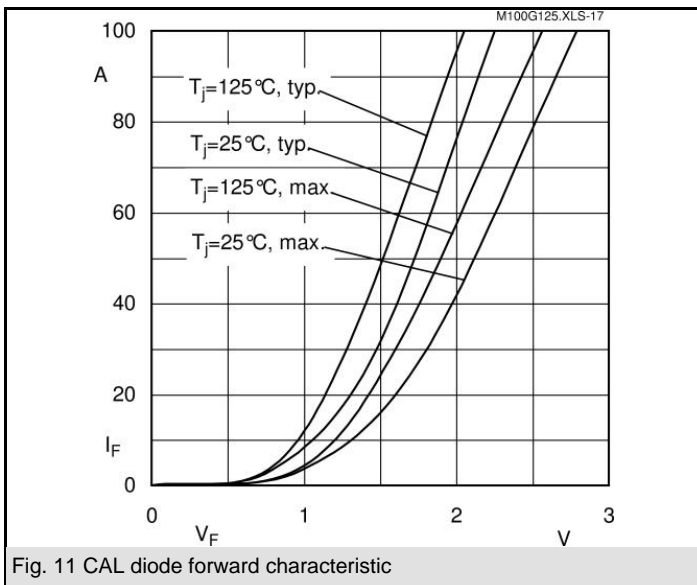
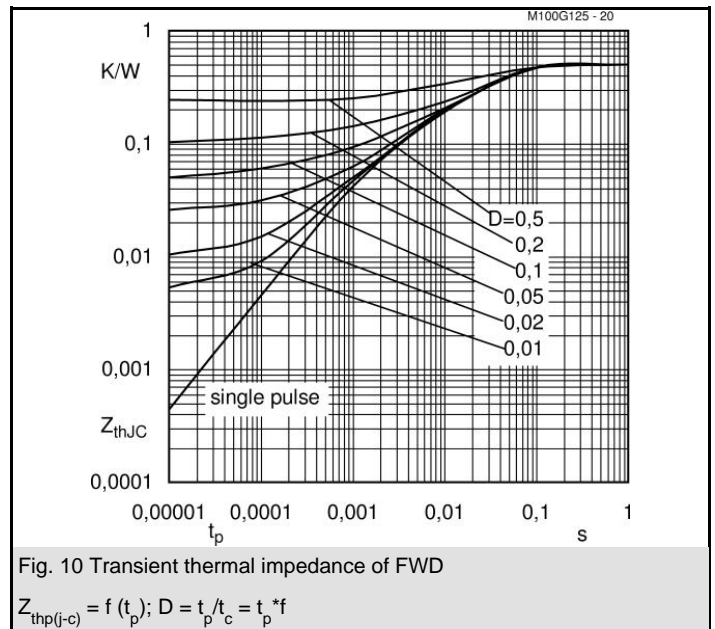
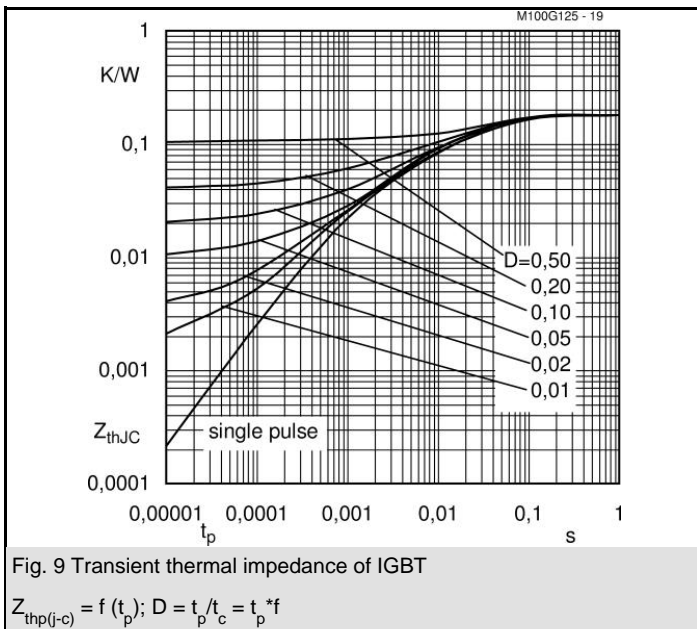
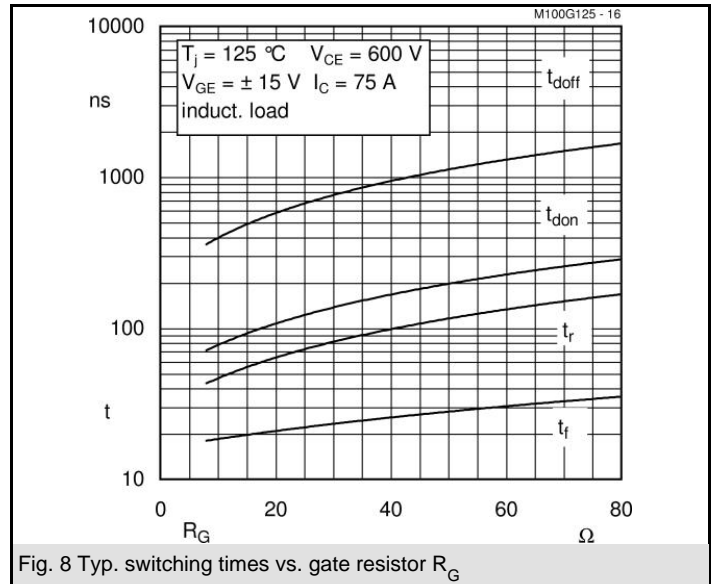
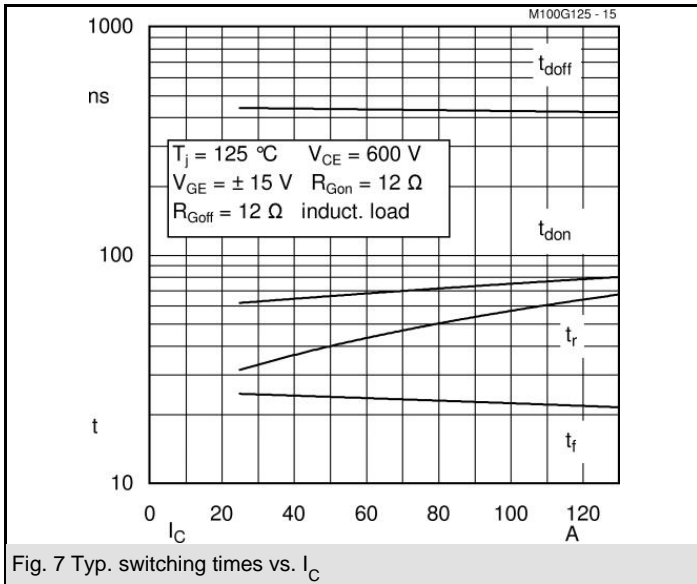

SKM 100GB125DN

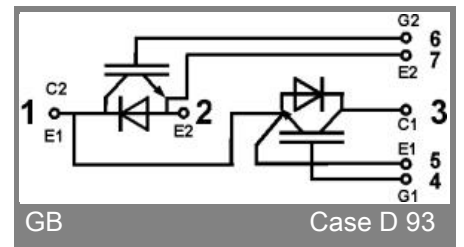
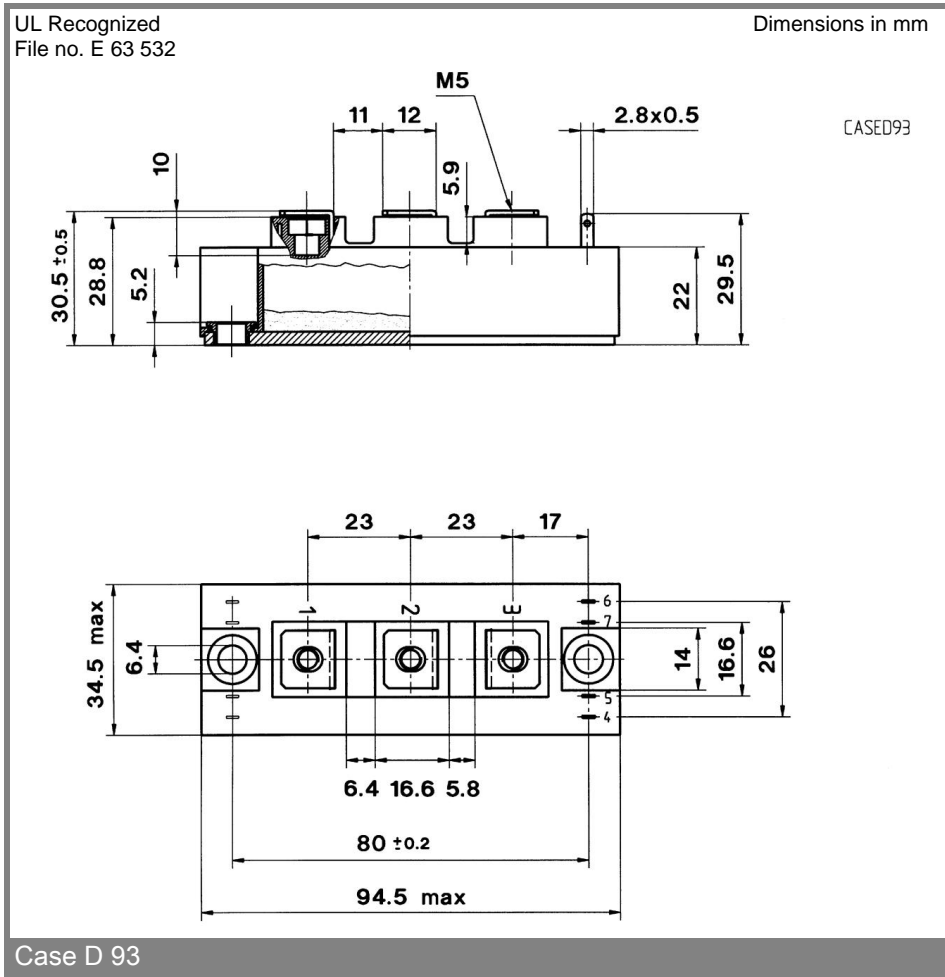
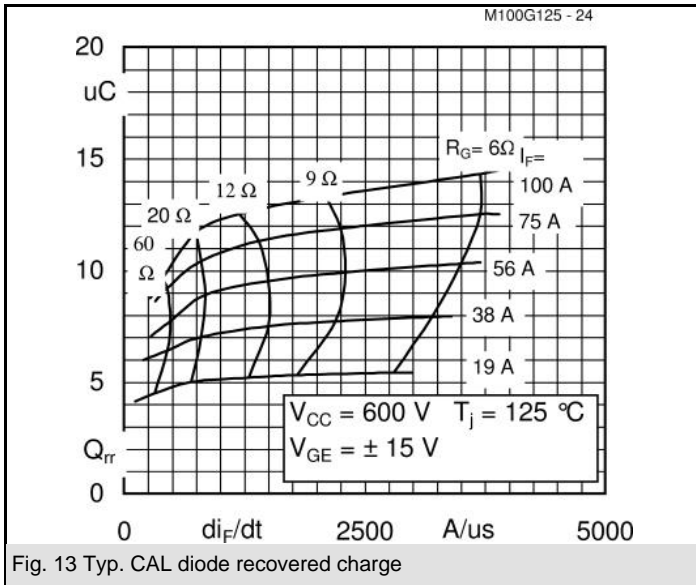

This is an electrostatic discharge sensitive device (ESDS), international standard IEC 60747-1, Chapter IX.

This technical information specifies semiconductor devices but promises no characteristics. No warranty or guarantee expressed or implied is made regarding delivery, performance or suitability.